

English	2
Español	19
Français	36

# HIGH PRESSURE WASHER OPERATOR MANUAL

Model Overview	3
Important Safety Instructions	4
Assembly Instructions	6
Operating Instructions	6
Using the Accessories	8
Working with Detergents	9
Taking a Break	10
Shutting Down & Clean-Up	10
Winterizing and Long-Term Storage	11
Maintenance Instructions	11
Cleaning Tips	12
Optional Cleaning Accessories	13
Troubleshooting	15

## Safety Alert Symbols

### **⚠ DANGER**

*indicates "an imminently hazardous situation which, if not avoided, will result in death or serious injury."*

### **⚠ WARNING**

*indicates "a potentially hazardous situation which, if not avoided, could result in death or injury."*

### **⚠ CAUTION**

*indicates "a potentially hazardous situation which, if not avoided, may result in minor or moderate injury or in property damage incidents."*

## Specifications

Max. Pressure	1600 PSI
Max. Water Flow	1.25 GPM
Amp draw	13 AMPS
Voltage	120 V
Part No.	1.601-680.0
Serial no.	

***For household use only!***

## Owner/User Responsibility

The owner and/or user must have an understanding of the manufacturer's operating instructions and warnings before using this pressure washer.

Warning information should be emphasized and understood.

If the operator is not fluent in English, the manufacturer's instructions and warnings shall be read to and discussed with the operator in the operator's native language by the purchaser/owner, making sure that the operator comprehends its contents.

Owner and/or user must study and maintain for future reference the manufacturers' instructions.

## Customer Support USA and Canada

In the U.S. or Canada, please call **1-800-537-4129** for warranty issues and visit **[www.karcher-help.com](http://www.karcher-help.com)** for technical support and product assistance.

Please take a moment to register your pressure washer online at **[www.karcher-register.com](http://www.karcher-register.com)**. Be sure to save your purchase receipt, it will be required for repairs covered by warranty.

## Customer Support Mexico

Call: **01-800-024-13-13** for help or visit our website: **[www.karcher.com.mx](http://www.karcher.com.mx)**

## MODEL OVERVIEW

- 1 High pressure outlet
- 2 ON/OFF switch
- 3 Hose/Cord Hook
- 4 Handle
- 5 Spray Wand Storage
- 6 Water inlet with garden hose connector
- 7 Detergent suction tube with filter
- 8 Power cord with Ground Fault Circuit Interrupter (GFCI)
- 9 Wheels
- 10 Trigger gun
- 11 Trigger gun safety lock
- 12 Locking slide for high pressure hose
- 13 High pressure hose
- 14 Dirtblaster® (Rotary spray wand)
- 15 Vario Power Spray wand

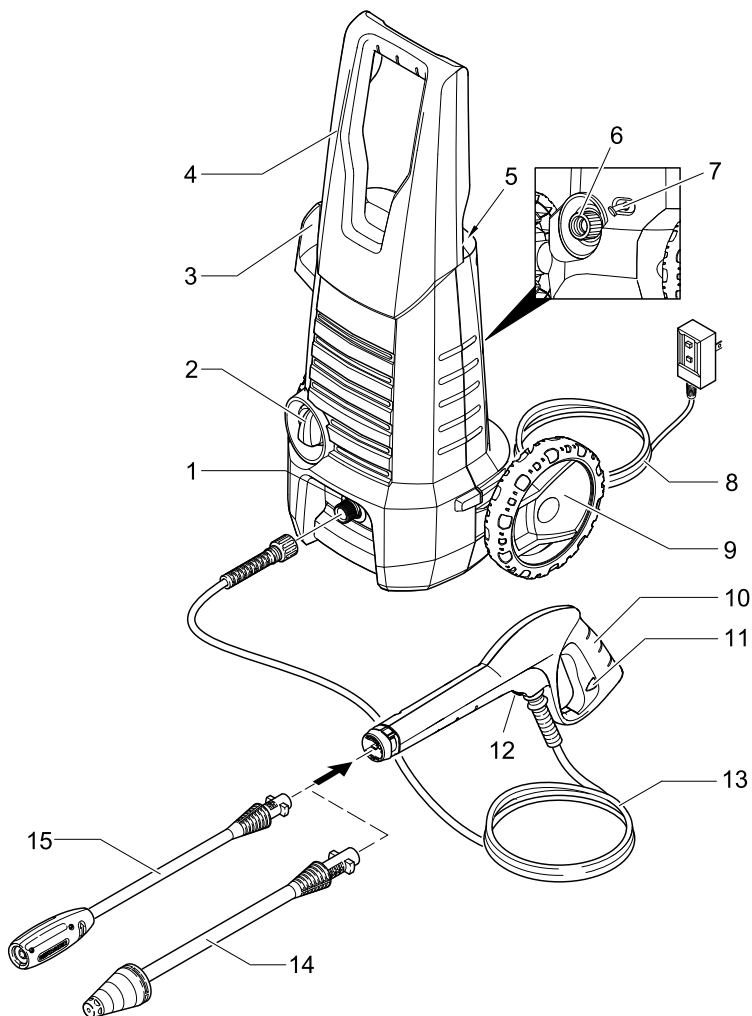

# IMPORTANT SAFETY INSTRUCTIONS

## **⚠ WARNING**

When using this product basic precautions should always be followed, including the following:

- Read all the instructions before using the product.
- To reduce the risk of injury, close supervision is necessary when a product is used near children.
- Know how to stop the product and bleed pressures quickly. Be thoroughly familiar with the controls.
- Stay alert – watch what you are doing.
- Do not operate the product when fatigued or under the influence of alcohol or drugs.
- Keep operating area clear of all persons.
- Do not overreach or stand on unstable support. Keep good footing and balance at all times.
- Follow the maintenance instructions specified in the manual.
- This product is provided with a Ground Fault Circuit Interrupter built into the power cord plug. If replacement of the plug or cord is needed, use only identical replacement parts.

## **⚠ WARNING**

*Risk of Injection or Injury – Do Not Direct Discharge Stream At Persons.*

- High pressure jets can be dangerous if misused. The jet must not be directed at persons, animals, electrical devices, or the unit itself.
- Wear safety goggles.

## **⚠ WARNING**

*Risk Of Explosion – Do not spray flammable liquids.*

- Do not use acids, alkaline, solvents, or any flammable material in this product. These products can cause

*physical injuries to the operator and irreversible damage to the machine.*

## **⚠ CAUTION**

*Gun Kicks Back – Hold with both hands.*

- The Trigger Gun Safety Lock prevents the trigger from accidentally being engaged. This safety feature DOES NOT lock trigger in the ON position.

## **⚠ WARNING – Risk of Electrocutation**

- Inspect cord before using – Do not use if cord is damaged.
- Keep all connections dry and off the ground.
- Do not touch plug with wet hands.
- Do not use extension cord with this product.
- Connect to individual branch circuit only.

## **⚠ CAUTION**

*This unit has been designed for use with cleaning detergents recommended by the manufacturer. The use of other cleaning detergents may affect the operation of the machine and void the warranty.*

## **⚠ WARNING**

- DO NOT SPRAY ELECTRICAL APPARATUS AND WIRING.
- DO NOT USE WITH FLAMMABLE LIQUIDS AND TOXIC CHEMICALS.
- HIGH PRESSURE. KEEP CLEAR OF NOZZLE.
- INJECTION HAZARD: EQUIPMENT CAN CAUSE SERIOUS INJURY IF THE SPRAY PENETRATES THE SKIN. DO NOT POINT THE GUN AT ANYONE OR ANY PART OF THE BODY. IN CASE OF PENETRATION SEEK MEDICAL AID IMMEDIATELY.

- THIS SYSTEM IS CAPABLE OF PRODUCING 1600 PSI TO AVOID RUPTURE AND INJURY, DO NOT OPERATE THIS PUMP WITH COMPONENTS RATED LESS THAN 1600 PSI WORKING PRESSURE (INCLUDING BUT NOT LIMITED TO SPRAY GUNS, HOSE AND HOSE CONNECTIONS).
- BEFORE SERVICING, CLEANING OR REMOVING ANY PARTS, SHUT OFF POWER AND RELIEVE PRESSURE.
- IF CONNECTION IS MADE TO A POTABLE WATER SYSTEM, THE SYSTEM SHALL BE PROTECTED AGAINST BACKFLOW.

### GROUND FAULT CIRCUIT INTERRUPTER PROTECTION

This pressure washer is provided with a ground-fault circuit-interrupter (GFCI) built into the plug of the power-supply cord. This device provides additional protection from the risk of electric shock. Should replacement of the plug or cord become necessary, use only identical replacement parts that include GFCI protection.

### SERVICING OF A DOUBLE-INSULATED PRODUCT

In a double-insulated product, two systems of insulation are provided instead of grounding. No grounding means is provided on a double-insulated product, nor should a means for grounding be added to the product. Servicing a double-insulated product requires extreme care and knowledge of the system, and should be done only by qualified service personnel. Replacement parts for a double-insulated product must be identical

to the parts they replace. A double-insulated product is marked with the words "DOUBLE INSULATION" or "DOUBLE INSULATED". The symbol "Ⓜ" may also be marked on the product.

### WATER SUPPLY (Cold Water Only)

#### **⚠ CAUTION**

*When connecting the water inlet to the water supply mains, local regulations of your water company must be observed. In some areas the unit must not be connected directly to the public drinking water supply. This is to ensure that there is no feedback of chemicals into the water supply. Direct connection via a receiver tank or backflow preventer, for example, is permitted.*

*Dirt in the feed water will damage the unit. To avoid this risk, we recommend fitting a water filter.*

- Garden hose must be at least 1/2 inch or 5/8 inch in diameter.
- Flow rate of water supply must not fall below 2 GPM (gallons per minute).
- Flow rate can be determined by running the water for one minute into an empty 5-gallon container.
- The water supply temperature must not exceed 104°F/40°C.
- Never use the pressure washer to draw in water contaminated with solvents, e.g. paint thinners, gasoline, oil, etc.
- Always prevent debris from being drawn into the unit by using a clean water source.

**SAVE THESE INSTRUCTIONS!**

# ASSEMBLY INSTRUCTIONS

## Required tools

**Screwdriver, small size** (not supplied) for connecting high pressure hose and trigger gun.

## Assembly

### → STEP 1:

Insert wheels into the side holes of the unit.

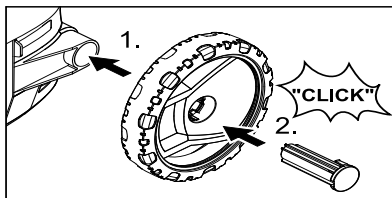

### → STEP 2:

Slide the transport handle into place.

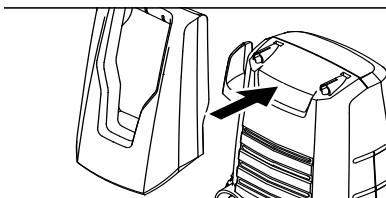

### → STEP 3:

- A Pull out the locking slide of the trigger gun handle.
- B Insert the small end of the high pressure hose into place.
- C Push the locking slide back into the trigger gun to lock the hose in position.

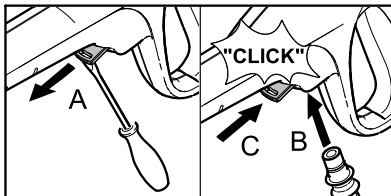

# OPERATING INSTRUCTIONS

### → STEP 1:

Connect the high pressure hose to the unit's high pressure outlet.

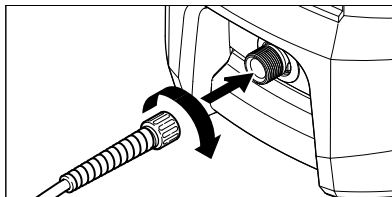

### → STEP 2:

Insert the spray wand of your choice into the trigger gun. Press in against the spring tension and twist into locked position.

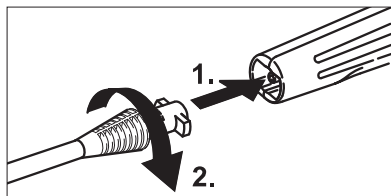

→ **STEP 3:**

Connect garden hose to unit's water inlet.

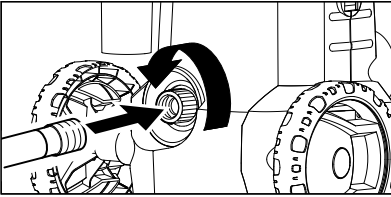

→ **STEP 4:**

Connect garden hose to the cold water source and turn water on completely.

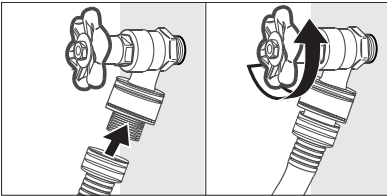

→ **STEP 5:**

Plug the Ground Fault Circuit Interrupter (GFCI) into a receptacle. Press RESET button, indicator should be "ON".

Press TEST button, indicator should be "OFF".

Press RESET button for use.

*We recommend that you test the GFCI as part of your startup procedure each time you use your pressure washer. To learn how to perform this test on your unit, visit [http://www.karcherresidential.com/gfci\\_test.php](http://www.karcherresidential.com/gfci_test.php) for detailed instructions for your type of GFCI.*

**⚠ WARNING**

Do not use if above test fails.

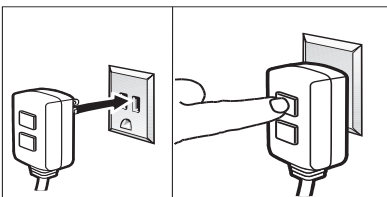

→ **STEP 6:**

Unlock the trigger gun safety lock. Trigger the gun to eliminate trapped air, wait for a steady flow of water to emerge from the spray nozzle.

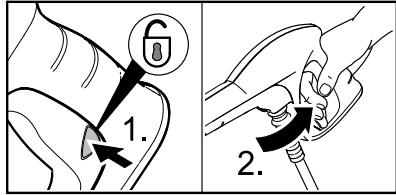

→ **STEP 7:**

Turn on the high pressure washer (I/ON).

**The motor starts only if the trigger of the gun is pulled and shuts off when the trigger is released.**

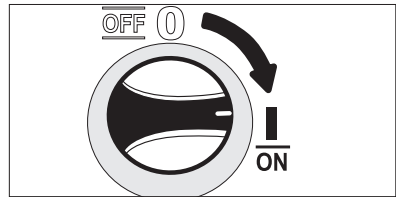

## USING THE ACCESSORIES

### **⚠ WARNING**

To avoid serious injury never point spray nozzle at yourself, other persons or animals.

Always test an inconspicuous area before cleaning with high pressure.

### Vario Power Spray Wand

- The Vario Power Spray Wand allows you to adjust the cleaning pressure. To clean at maximum pressure, the wand must be positioned to the high pressure setting (Max).

For reduced pressure turn the wand collar in the „Min“ direction.

**To apply detergent, the wand must be positioned to the low pressure setting (Mix).**

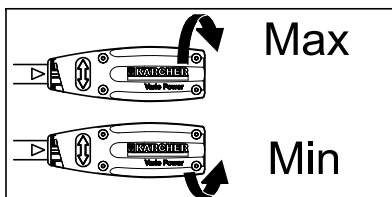

### Dirtblaster®

- This nozzle features a 0° pencil jet which rotates 360° for maximum dirt cutting action, effectively increasing cleaning performance up to 50%. This nozzle combines the cleaning performance of a 0° pencil jet with the surface coverage of a wide angle nozzle.

**Not recommended for soft materials, siding, painted surfaces, decks or autos.**

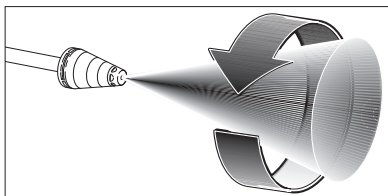

- Before cleaning any surface an inconspicuous area should be cleaned to test spray pattern and distance for maximum cleaning results.



## WORKING WITH DETERGENTS

Detergents can only be applied at low pressure (Min.).

→ **STEP 1:**

Install the Vario Power Spray Wand. Set the spray wand to the low pressure setting (Mix).

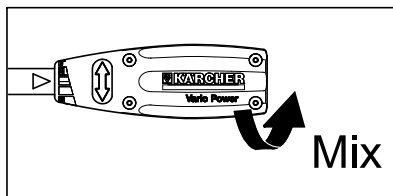

→ **STEP 2:**

Fill a container with Kärcher detergent. Place the filter end of detergent suction tube into the container.

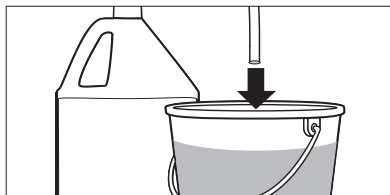

→ **STEP 3:**

Turn on the pressure washer (I). Pull trigger to operate unit. Liquid detergent is drawn into the unit and mixed with water. Apply detergent to work area. Do not allow detergent to dry on surface.

→ **STEP 4:**

To rinse, move the VPS out of „Mix“ position and pull trigger to operate unit.

→ **STEP 5:**

**Cleaning up:** Always draw fresh water through the detergent tank or siphon tube when done to flush any remaining detergents from the injection system.

For best results see **Cleaning Tips** for specific information on how to clean different surfaces.

**Always Use Kärcher® Detergent for Best Results**

Kärcher® biodegradable detergents are specially formulated to protect the environment and your pressure washer. The special formula won't clog the suction tube filter and will protect the internal parts of the pressure washer for a longer life. For Kärcher® Detergents, check your retailer or visit our website:

[www.soappac.com](http://www.soappac.com)

**⚠ CAUTION**

**Never use:**

- Bleach, Chlorine products and other corrosive chemicals
- Liquids containing solvents (i.e., paint thinners, gasoline, oils)
- Tri-sodium phosphate products
- Ammonia products
- Acid-based products

These chemicals will harm the unit and will damage the surface being cleaned.

**Use of these items will void the warranty.**

## TAKING A BREAK ..five minutes or more

→ **STEP 1:**

Release trigger and engage gun safety lock.

→ **STEP 2:**

Turn pressure washer to OFF (0) position.

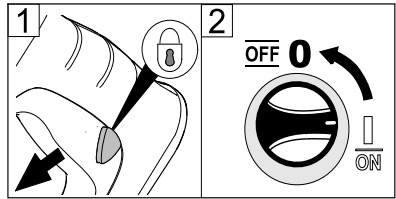

## SHUTTING DOWN & CLEAN-UP

→ **STEP 1:**

Turn the switch to OFF (0) position and unplug cord from outlet.

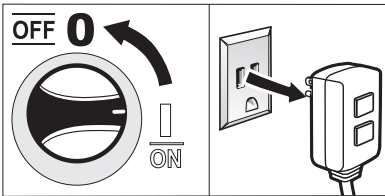

→ **STEP 5:**

Disconnect the garden hose from the water inlet on the unit.

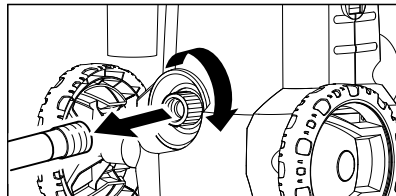

→ **STEP 2:**

Turn off the water source.

→ **STEP 3:**

Press trigger to release water pressure.

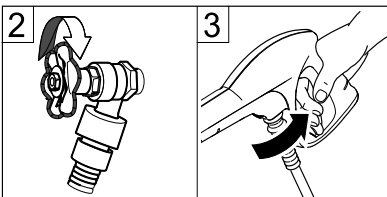

→ **STEP 6:**

Disconnect the high pressure hose from the high pressure outlet.

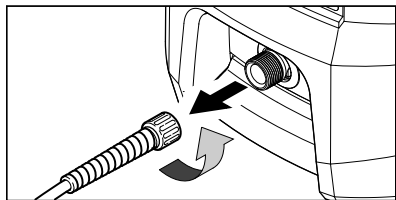

→ **STEP 4:**

Release trigger and engage gun safety lock.

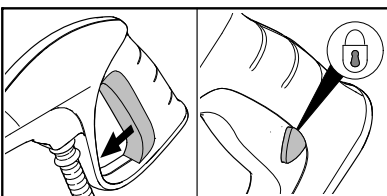

## WINTERIZING AND LONG-TERM STORAGE

- **1:** Disconnect all water connections.
- **2:** Turn on the machine for a few seconds, until the water which had remained in the pump exits, turn off immediately.
- **3:** Do not allow high pressure hose to become kinked.
- **4:** Store the machine and accessories in a room which does not reach freezing temperatures. **DO NOT** store near furnace or other sources of heat as it may dry out the pump seals.

### **⚠ CAUTION**

*Failure to follow the above directions will result in damage to the pump assembly and accessories and will void the warranty.*

*Kärcher® also recommends the regular practice of using a pump protector like "Kärcher® Pump Guard" to prevent cold weather damage during storage in the winter months.*

## CARE AND MAINTENANCE INSTRUCTIONS

### Cleaning the water inlet filter

- **STEP 1:**  
Pull out washer from the water inlet.
- **STEP 2:**  
Pull out water inlet filter with flat-nose pliers.

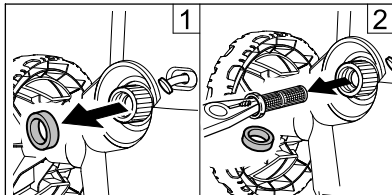

- **STEP 3:**  
Rinse out water inlet filter in warm water.
- **STEP 4:**  
Reinsert water inlet filter and washer into the water inlet.

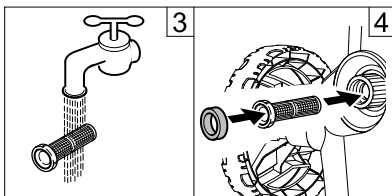

### Maintenance

The unit is maintenance-free.

## CLEANING TIPS

### **⚠ CAUTION**

- Before cleaning any surface an inconspicuous area should be cleaned to test spray pattern and distance for maximum cleaning results.
- If painted surfaces are peeling or chipping, use extreme caution as pressure washer may remove the loose paint from the surface.
- When using on surfaces which might come in contact with food, flush surfaces with plenty of drinking water.
- For additional cleaning tips and a complete video library, visit our website:

[www.karcherresidential.com](http://www.karcherresidential.com)

### **Deck Cleaning**

**(with or without detergent).** Pre-rinse deck and surrounding area with fresh water. If using detergent, apply to surface at low pressure. For best results, limit your work area to smaller sections of approximately 25 square feet. Allow detergent to remain on surface 1-3 minutes. Do not allow detergent to dry on surface. Rinse at high pressure in a long sweeping motion keeping the spray nozzle approximately 3-6 inches from the cleaning surface. Always clean from top to bottom and from left to right. When moving on to a new section of the cleaning surface, be sure to overlap the previous section to eliminate stop marks and ensure a more even cleaning result.

### **House Siding**

**(with or without detergent).** Pre-rinse cleaning surface with fresh water. If using detergent, apply to surface at low pressure (for best results, limit your

work area to sections of approximately 6 feet and always apply detergent from bottom to top). Allow detergent to remain on surface 1-3 minutes. Do not allow detergent to dry on surface, if surface appears to be drying, simply wet down surface with fresh water. If needed, use special wash brush attachment (not included) to remove stubborn dirt. Rinse at high pressure from top to bottom in an even sweeping motion keeping the spray nozzle approximately 6 inches from the cleaning surface.

### **Cement Patios, Brick and Stone**

**(with or without detergent).** Pre-rinse cleaning surface with fresh water. If using detergent or Degreaser, apply to surface at low pressure. For best results, limit your work area to smaller sections of approximately 25 square feet. Allow detergent or Degreaser to remain on surface 1-3 minutes. Do not allow detergent to dry on surface. Rinse at high pressure in a sweeping motion keeping the spray nozzle approximately 3-6 inches from the cleaning surface. Always clean from top to bottom and from left to right. For removing extremely stubborn stains, use the Dirtblaster® Nozzle.

### **Cars, Boats & Motorcycles**

**(with or without detergent).** Pre-rinse vehicle with fresh water. If using detergent, apply to surface at low pressure. For best results, clean one side of vehicle at a time and always apply detergent from bottom to top, do not allow detergent to dry on surface. If needed, use special wash brush attachment (not included) to remove stubborn dirt. Rinse

at high pressure in a sweeping motion keeping the spray nozzle approximately 6-8 inches from the cleaning surface (distance should increase when rinsing pin-striping or other sensitive surfaces). Always clean from top to bottom and from left to right. For best results, wipe surface dry with a chamois or soft dry cloth.

### **Barbecue Grills, Outdoor Power Equipment & Gardening Tools**

**(with or without detergent).** Pre-rinse cleaning surface with fresh water. If using detergent or Degreaser, apply detergent at low pressure. Allow detergent to remain on surface 1-3 minutes. Do not allow detergent to dry on surface. Rinse at high pressure keeping the spray nozzle approximately 3-6 inches from the

cleaning surface. For removing extremely stubborn dirt, it may be necessary to move the spray nozzle even closer to the surface for greater dirt cutting action.

### **Patio & Lawn Furniture**

**(with or without detergent).** Pre-rinse furniture and surrounding area with fresh water. If using detergent, apply to surface at low pressure. Allow detergent to remain on surface 1-3 minutes. Do not allow detergent to dry on surface. If needed use special Wash Brush Attachment (not included) to remove stubborn dirt. Rinse at high pressure in a sweeping motion keeping the spray nozzle approximately 3-6 inches from the cleaning surface. For best results, clean from top to bottom and from left to right.

## **OPTIONAL CLEANING ACCESSORIES**

*Optional accessories are available to further enhance your cleaning capabilities. These accessories are accurate as of the printing date of this manual. Please check our website for pricing and up-to-date information.*

### **Pump Guard**

Specially formulated to protect your pressure washer from freezing, corrosion and premature wear. The Pump Guard also adds lubrication to valves and seals to prevent sticking. Highly recommended for all Kärcher® pressure washers!

**Part No. 9.558-998.0**

### **25 Ft. Extension /Replacement High-Pressure Hose**

Replacement hose fits Kärcher® pressure washer with screw-on type gun connections from 2400 PSI to 2500 PSI, Extension Hose for all Kärcher® high pressure washers between the original equipment hose and machine up to 2500 PSI.

**Part No. 2.640-850.0**

### **66" Extension Wand (Four piece)**

Need to clean second story windows or other high areas? Increase the reach of your pressure washer by up to 66" with this extension kit. Includes 4 aluminum sections for variable length. 66" fully assembled. Fits most Kärcher® pressure washers up to 2300 PSI. (bayonet)

**Part No. 2.640-746.0**

### **Rotating Wash Brush (bayonet)**

For more effortless cleaning of all smooth surfaces (painted, glass and plastic) try the Kärcher® Rotating Wash Brush. Use it on your automobile, house siding or windows. The water pressure from your pressure washer causes the inner brushes to gently spin, making your cleaning job much easier. The angle of brush head is adjustable to help you reach difficult areas. Excellent for the application of detergent. A must-have accessory designed for Kärcher® pressure washers up to 2300 PSI. (bayonet)

**Part No. 2.640-743.0**

### **Soft Clean Washing Brush**

Made with soft bristles that will not harm painted surfaces. Easily attaches directly to the trigger gun. Ideal for stubborn dirt on cars, boats, patio furniture and other surfaces. Great for applying detergent. Fits most Kärcher® pressure washers up to 2300 PSI. (bayonet)

**Part No. 2.640-740.0**

### **25 ft. Pipe Cleaning Kit (bayonet)**

Need to clean blocked pipes, drains or downspouts? The Kärcher® pipe cleaning kit is the answer! The pipe cleaner propels itself forward while simultaneously flushing out debris. For example, insert the cleaning nozzle in the base of a downspout, pull the trigger on the pressure washer gun and watch as the nozzle shoots out leaves and other debris while climbing upward. Connects directly to the trigger gun of most Kärcher® pressure washers up to 2300 PSI. (bayonet)

**Part No. 2.640-747.0**

### **Wet Sandblasting Kit (bayonet)**

Why spend hours stripping old paint and rust by hand using harsh chemicals? Let the Kärcher® Wet Sandblasting Kit do the work! Attach the kit to your pressure washer, add abrasive material and attack the rust and paint with our eco-friendly alternative. Fits most Kärcher® pressure washers up to 2300 PSI. (bayonet)

**Part No. 2.638-792.0**

### **Detergent Foamer Attachment**

Ideal for applications which require a thick foam. Simply fill the reservoir cup with liquid pressure washer detergent to generate a foam spray. Connects directly to the trigger gun. Fits most Kärcher® pressure washers up to 2300 PSI. (bayonet)

**Part No. 6.964-507.0**

### **T 100 Wide Area Surface Cleaner**

For cleaning surfaces such as patios, terraces and driveways without splash-back, there is no better solution than the Kärcher® T 100. It saves time by cleaning a one foot wide area gently as it hovers, providing consistent, streak-free cleaning. When you finish cleaning the patio and driveway, remove the wand and use the handle to clean garage doors and other vertical surfaces. Includes two nozzles which spin at high speed for optimum results. Our top selling accessory for Kärcher® pressure washers up to 2300 PSI. (bayonet)

**Part No. 2.640-959.0**

## TROUBLESHOOTING

### **⚠ CAUTION**

*Disconnect the machine from the power source before making any repair.*

Symptom	Cause	Solution
Motor will not start	On/Off switch is in the "OFF" (0) position.	Turn switch to the "ON" (I) position
	Power cord is not plugged in.	Plug in power cord.
	Electrical outlet does not supply adequate power.	Try a different outlet.
	Tripped GFCI plug.	Press "RESET" button on GFCI plug.
Unit does not reach high pressure.	Diameter of garden hose is too small.	Replace with a 5/8 inch or larger garden hose.
	Water supply is restricted.	Check garden hose for kinks, leaks and blockage.
	Not enough inlet water supply.	Open water source full force.
	Water inlet filter is clogged.	Remove filter and rinse out in warm water.
	Spray wand is on low pressure position.	Turn spray wand to high pressure position.
Output pressure varies high and low.	Not enough inlet water supply.	Turn water on full force. Check garden hose for kinks, leaks or blockage.
	Pump is sucking air.	Check that hoses and fittings are air tight. Turn off machine and purge pump by squeezing trigger gun until a steady flow of water emerges through the nozzle.
	Water inlet filter is clogged.	Remove filter and rinse out in warm water.
	Discharge nozzle is obstructed.	Blow out or remove debris with a fine needle.
	Calcified gun, hose or spray wand.	Run distilled vinegar through detergent suction tube.

Symptom	Cause	Solution
No detergent.	Detergent is too thick.	Dilute detergent, for best results use Kärcher® detergent.
	Filter on detergent suction tube is clogged.	Run warm water through filter to remove debris.
	Damaged or clogged detergent suction tube.	Remove obstruction or replace detergent suction tube.
	Spray wand is in high pressure position.	Turn spray wand tip to low pressure position.
	Discharge nozzle is obstructed.	Blow out or remove debris with fine needle.
Garden hose connection leaks.	Loose fittings.	Tighten fittings.
	Missing/worn rubber washer.	Insert new washer.
Spray wand leaks.	Spray wand not properly attached.	Insert the spray wand into the trigger gun. Carefully press in against the spring tension and twist into the locked position.
	Broken o-ring or plastic insert.	Call Customer Support
Pump is noisy.	Pump is sucking air.	Check that hoses and fittings are air tight. Turn off machine and purge pump by squeezing trigger gun until a steady flow of water emerges through the nozzle.
Water leaks from pump (up to 10 drops per minute is permissible).	Loose fittings.	Check that all fittings are tight.
	Water seals are damaged or worn.	Call Customer Support
Oil Drip.	Oil seals are damaged or worn.	Call Customer Support

If you encounter any additional difficulties not listed, please visit our website.

**USA / Canada:**

[www.karcher-help.com](http://www.karcher-help.com)

**México:**

[www.karcher.com.mx](http://www.karcher.com.mx)